

Optimization design and experiment for pv/t system based on the convection thermal transfer theory

WENPING XIAO², YUNLIN SUN³, LIRONG ZHANG²,
SHOUQIANG QIU⁴

Abstract. Current research and application of solar Photo-Voltaic/Thermal collector (PV/T) system is still very inadequate, due to the limitation of the cost and performance. The design of its water cooling device is still stuck in the stage of experimental methods. In this paper, a kind of U type tube water cooler with low difficulty technology is taken as the research object, and the balance between the incident solar thermal energy of PV/T and the heat absorbing capacity of the U type tube is also taken as the objective. We analyze the heat transfer coefficient of the cooling water in laminar flow, transitional flow and turbulent flow respectively, and optimize the water velocity in the U type tube, the diameter and the length of the tube for a reasonable design. The Bernoulli number is calculated by the D.K.Edwards and Gnielinski calculation formula respectively. The calculation result shows that the cooling water is not enough to absorb the solar incident heat power in low velocity state of laminar flow. If the speech is rise up to the transitional or the turbulent flow, we choose a standard 25mm diameter tube and design the length of the tube as 8m in per square meter. The optical flow rate is between 0.05 and 0.3ms⁻¹. Thus the cooling water could meet the thermal absorption requirements. The model test of PV/T is carried out according to the optimized result. The comparison between the conclusion of experimental data analysis and the reference shows that the optimization design method based on the theory of convection heat transfer is effective, which can provide theoretical basis for the design of PV/T water cooling device.

Key words. PV/T system, parameter optimization, heat transfer coefficient, comprehensive efficiency.

¹Acknowledgment-The authors would like to thank the engineers, like Jinyang Li and Jiang Li, for their help in system experimentation. The authors are also grateful to the financial support of the foundations: (1) The natural science foundation of Guangdong Province, the research of photo-voltaic energy saving system modeling, design and application of industrial plants in the Pearl River Delta Area (2015A030310522); (2) University of Guangdong province (Development) heat pump engineering technology research center project, research on commercial household PV/T environment system (2014- KJZX0056); (3) Higher Vocational Education Teaching Reform Project Fund of Guangdong Province, China (201401300).

²Workshop 1 - Shunde Polytechnic, Shunde Guangdong 528300, China;e-mail: xwp556@126.com

³Workshop 2 - Solar Energy Research Institute of Sun Yat-sen University, Guangzhou 516000, China

⁴Workshop 3 - South China University of Technology, Guangzhou, 516400, China

1. Introduction

The application of the independent and the grid-connect photovoltaic (PV) power system has been more and more popular. However, one of the dominant factor that restricting its application is the high cost of power generation, which is much higher than the cost of hydropower and thermal power. Therefore, it is difficult to make economic sense in PV industry without the government support and subsidies. Moreover, the utilization rate of the solar energy in the pure PV power system is low, hovering at around 18%. The thermal energy transformed by most of the incident solar energy would raise the temperature of the PV modules, even as high as 80?? on somewhere. As the result, high temperature would reduce the power generation efficiency further [1]. Photo-Voltaic/Thermal collector (PV/T) combined the application of photovoltaic and solar-thermal could adopt this heat by mediums such as water and air. The hot water produced by PV/T system could be applied to civil life and industrial sector.

Currently, there is not large-scale commercial product with PV/T system because of its technique immaturity. One of the main factor of restricting its application is the complexity of the manufacture technics, which is not suitable for mass production to reduce the cost. The other one is the low heat energy utilization efficiency. Hence, the study on PV/T system for comprehensive utilization has drew much attention. Bergene T et al [2]. proposed that the efficiency of PV/T system can reach 60%~80% by theory analysis. Lu Dan et al. [3] has carried on the preliminary experiment research for the electrothermal properties of PV/T system. Zhu Huijuan et al.[4] employed 80mm and 140mm tube pitch in the experiment. The result shows that the pitch of 80mm has better performance than of 140mm.

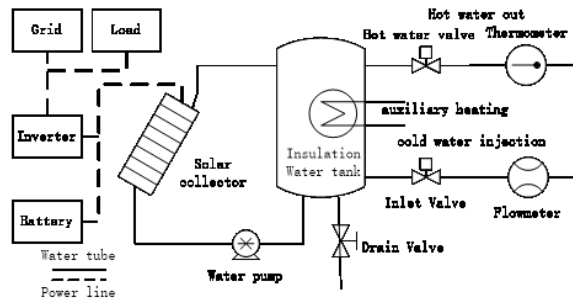

Fig. 1. Structure of PV/T system

2. System Structure Design

The photovoltaic part in the PV power system application has always been focused for a long time. While the potential of photo-thermal has been ignored. Therefore, there is lack of investment on the photo-thermal. PV/T is one kind of the photo-thermal application based on photovoltaic power generation, where the

absorbed energy with solar-thermal effect and even the economic benefit are higher than the pure photovoltaic power generation. For further consideration, in order to improve the efficient of the solar-thermal application, this paper proposes a new kind of thermal collector with simple technique, high reliability, using the U tuber structure which is widely applied into the air condition and refrigerator[5].Figure 1 is s the structure chart of the PV/T system. The profile and structure of the collector is shown in Figure 2. the structure of PV/T system is mainly composed of photovoltaic power system and water circulation system, and the water circulation system contains collector, 50 litres heat preservation water tank, pipe, valve, auxiliary heater, flow meter, thermometer, controller, etc. The layered structure of the

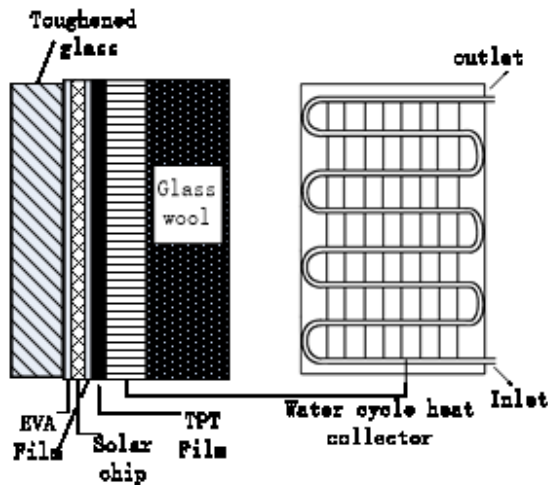

Fig. 2. Schematic diagram of PV/T heat collector

PV/T collector is shown in Figure 2. The components of each layer include toughened glass, Ethyl Vinyl Acetate (EVA) film, Solar cell chip, Tedlar Polyster Tedlar (TPT) film, water circulating cooling heat collector, and the glass wool insulation layer. The dimensions and the physical parameters of each layer are listed in table 1:

3. Analysis on the convection heat transfer performance of PV/T collector

Based on the structure of Figure 2, a single solar cell collector module with the size of 1200mm*1000mm and the area of 1.2 m² is used for the research object. Water is taken as the refrigerant for heat absorption. Assumes that the inlet temperature is 25 , the outlet temperature is 65 , the average temperature is 45 . The features of water under 45 is shown in table 2.

Table 1 the dimension and heat transfer performance of each layer

Material\parameter	Thermal conductivity (W/(m/K))	Specific heat capacity (J/kg/K)	Thickness (mm)	Coefficient of thermal expansion (m/K)
Toughened glass	6	945	3.2	0.6E-6
EVA film	0.22	700	0.5	1E-5
Solar cell chip	24	900	0.3	2.5E-6
TPT film	0.26	700	0.3	8E-6
Thermal conductive adhesive	1.2	700	2	1E-5
Aluminum alloy	149	875	3	2.3E-5
Cooling water	60.75	4200	15	0.00435(30)
Heat insulation cotton	0.036	1200	20	

Table 2. Characteristic parameters of water at 45

Thermal conductivity λ W(m ² qK) ⁻¹	Density ρ Kgm-	Specific heat capacity Cp kJ(kg qK) ⁻¹
0.642	990.2	4.174
Kinematic viscosity ν m ² s ⁻¹	Dynamic viscosity η Paqs	Prandtl number Pr
6.075E-07	6.014E-04	3.93

4. Influence of velocity on the performance of heat transfer

According to the research achievement of the literature [6], we adopt the d=25mm standard U-shape tube and arrange there tubes with the 80mm spacing. The total length of pipe on each solar panel is about 10m. The heat transfer coefficient under different flow rate is calculated as follow.

(1)Laminar flow. When the flow velocity in the cooling tube is slow, the influence for flow field generated by the viscous force of fluid is greater than the inertia force. It is so called the laminar flow regime that the maximum flow velocity of the fluid could be accessed in the tube center, while the minimum is near the tube wall. The average flow velocity in the tube is u , so the Reynolds number is:

$$Re = \frac{ud}{\nu} = \frac{u * 0.025}{6.075 * 10^{-7}} = 4.115 * 10^4 * u \quad (1)$$

In the smooth tube, $Re < 2300$, so that $u < 0.0535 m s^{-1}$, the interior flow is in a

laminar flow state. According to the D.E.Edwards calculation formula:

$$Nu = 3.66 + \frac{0.0668Re Pr(d/L)}{1 + 0.04[Re Pr(d/L)]^{2/3}} = \frac{225.07u}{1 + 0.04(3369u)^{2/3}} \quad (2)$$

$$h = Nu \frac{\lambda}{d} = Nu \frac{0.642}{0.025} = \frac{5779.8u}{1 + 0.04(3369u)^{2/3}} \text{ W}/(\text{m}^2 \bullet \text{K}) \quad (3)$$

Figure 3 shows the corresponding curve of the heat transfer coefficient when the flow velocity vary from 0.01 to 0.054.

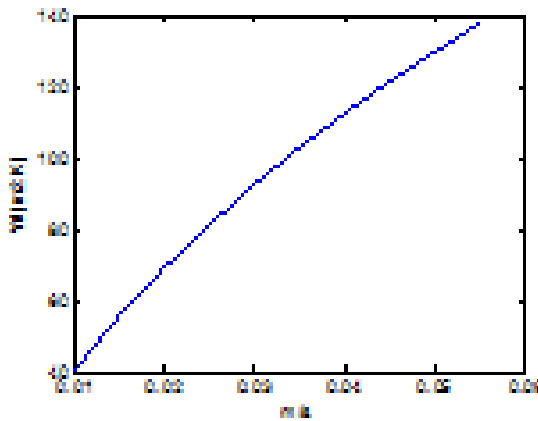

Fig. 3. The relation between the flow rate and the convective heat transfer coefficient over laminar flow

In the case of low speed laminar flow, due to the smaller diameter, the convection heat transfer coefficient of the collector is between $40 \sim 140 \text{ Wm}^{-2}\text{K}^{-1}$, and the heat absorption capacity is not particularly good.

(3) Transitional flow and turbulence. With the flow rate increasing gradually, the influence on the flow field generated by inertia force is greater than by the viscous force. The fluid flow becomes unstable gradually, and a flow field of disorder and irregular turbulent would be developed and enhanced gradually. There has sliding between the adjacent laminar flow, as well as mixture. Then the fluid moving irregularly generates a component of velocity, and the direction of the velocity is perpendicular to the axis of the flow tube. This movement is called turbulence, also known as turbulence, turbulent flow or turbulent flow.

According to equation (1), when $Re > 2300$, the system is in the state of turbulent flow. The gurney linski calculation formula is used to calculate the Nusselt number [5]:

$$Nu = \frac{(f/8)(Re - 1000)Pr}{1.07 + 12.7\sqrt{f/8}(Pr^{2/3} - 1)} \quad (4)$$

The friction factor is shown:

$$f = [0.79 \ln Re - 1.64]^{-2} \quad (5)$$

The coefficient of average convection heat transfer is obtained as follows:

$$h = Nu \frac{\lambda}{d} = 25.68 Nu \quad Wm^{-2} \bullet ^\circ C^{-1} \quad (6)$$

Figure 4 shows the corresponding curve of the heat transfer coefficient when the flow velocity vary from 0.05 to 0.03.

5. Influence of tube diameter on the heat transfer performance

Based on the analysis results of the part 2.1, we select the state of turbulent flow and the flow rate 0.16ms-1 corresponding to the solar incident power of $1000Wm^{-2}$. According to the formulas (4-6), the relationship between the diameter of the pipe diameter changed from 0.01m to 0.1m and the heat transfer performance could be drawn as shown in Figure 5.

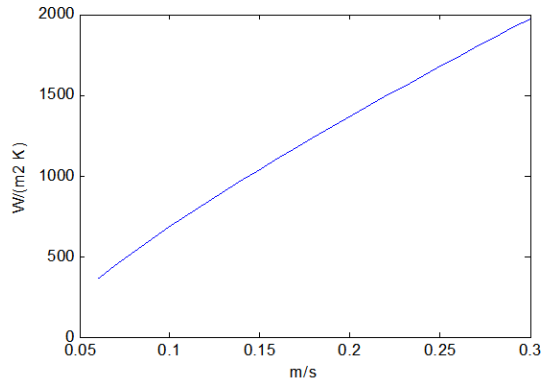

Fig. 4. The relationship between the flow rate and the convective heat transfer coefficient over turbulent flow

As shown in Figure 5, the diameter between 0.02m-0.03m has the optimal solution, and the standard diameter of 0.025 is in the optimal range, hence we select 0.025m for appropriate diameter.

6. The correlation of the tube length and the coefficient of heat transfer

The solar power incidence is similar to that of a heating process with constant heat flux. According to the literature [7], the area around Guangzhou is a

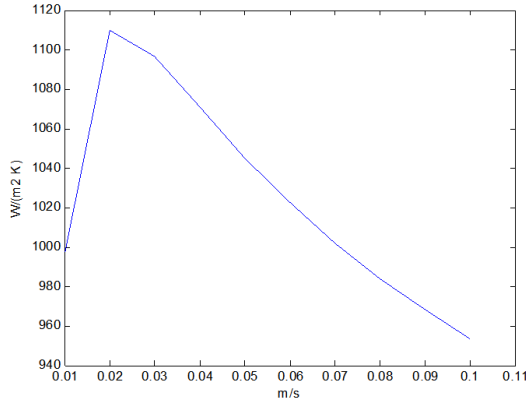

Fig. 5. The relation between the diameter of pipe and the heat transfer coefficient

rich area for solar energy resource. The average annual total solar radiation is $24279.58 \text{ MJ m}^{-2}$, and the average monthly total radiation in July up to (475.22 MJ m^{-2}), at least in February (226.67 MJ m^{-2}). Solar energy is the most abundant in the time between 10:00-14:00. The average hourly radiation intensity of the annual average is more than 1.45 MJ m^{-2} , the maximum radiation power is about 1250 W m^{-2} . We choose 1200 W m^{-2} as the power of constant heat flux, since the PV/T system should be left a certain allowance compared to the maximum power.

Using the convection heat transfer formula (only the upper surface of the pipe heat):

$$\Phi = h(\pi d/2)L\Delta t_m \quad (7)$$

Thus the minimum tube length is induced as follow:

$$L = \Phi/h(\pi d/2)\Delta t_m \quad (8)$$

In formula (8), we select the peak radiation power of $\Phi = 1200$, and set the system water temperature increased from 25 to 65.[8]. There are totally four solar panel modules in this system, and each module's temperature rise is $\Delta t_m = 10$. The tube is selected the standard tube, as $d=0.025 \text{ m}$. Put these parameter into formula (8), get:

$$L = 1200/(h(3.1415 * 0.025/2) * 10) = 3055.9/h \quad (9)$$

7. Comprehensive optimization

In order to manufacture the heat absorber, the tube diameter of $d=0.025 \text{ m}$ is determined. Considering the balance of the heat absorption ability and the heat conduction of U tube, U tubes are arranged uniformly on the solar panel modules, and the spacing of each tube is 120mm. So the length of single component is of $L=8 \text{ m}$.

Put L into formula (9), get:

$$h = 3055.9/L = 382.1 \text{ W m}^{-2} \bullet \text{K}^{-1} \quad (10)$$

According to formula (6) and Figure 4, a certain margin must be retained considering the problem of heat transfer. The flow rate is taken as $u=0.05 \text{ m s}^{-1}$. Thus, the design parameters of the optimal water cooling device are calculated.

8. Analysis of optimized water-cooling characteristics

Because the incidence of solar energy is unstable, the temperature of the solar module are changing with the heat flux of solar energy, this is a non-steady state thermal conductivity process. The heat transfer model of the cooling water pipe can be simplified as a hollow cylinder as shown in Fig. 6 with an outer diameter d of 25 mm and a thickness δ of 2.5 mm. Assuming the initial temperature of the outer wall of the aluminum alloy pipe is t_{Al} , the initial temperature of the cooling water is t_{water} , the temperature after the heat transfer equilibrium is t_B , the convective heat transfer coefficient between the inner surface of the water pipe and the cooling water is h . By energy conservation ruler, heat conduction is equal to the cooling water convection per unit time, so

$$V \rho c \frac{dt}{d\tau} = -hA(t - t_{water}) \quad (11)$$

Let $\theta = t - t_B$ as excess temperature, and formula 11 becomes

$$\rho c V \frac{d\theta}{d\tau} = -hA(\theta + t_B - t_{water}) \quad (12)$$

From the initial temperature t_{Al} , the initial condition is given

$$\theta(0) = t_{Al} - t_B = \theta_0 \quad (13)$$

Separate the variables and then integrate,

$$\int_{\theta_0}^{\theta} \frac{d\theta}{\theta} = - \int_0^{\tau} \frac{hA}{\rho c V} d\tau \quad (14)$$

The solution is

$$\theta = \theta_0 \exp\left(-\frac{hA}{\rho c V} \tau\right) \quad (15)$$

8.1. Geometry of the plate

Consider a non-homogeneous thin symmetric trapezoidal plate of varying thickness and density. The geometry of the plate is shown in Fig. 1.

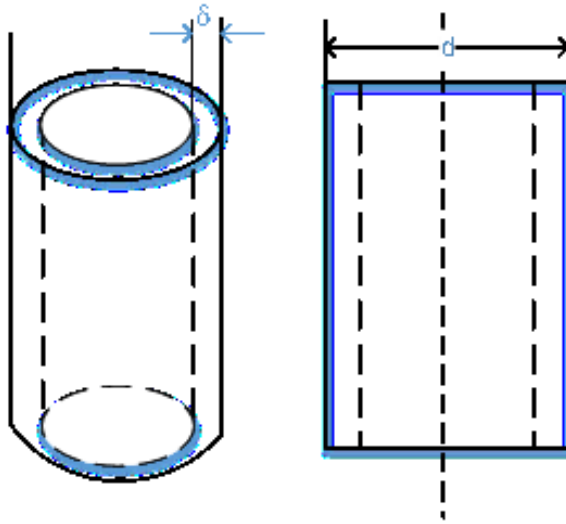

Fig. 6. Simplified model of heat transfer in cooling water pipes



Fig. 7. Actual setup of the PV / T system test rig

9. Summary

In order to improve the performance and the commercial value of PV/T system, firstly, a heat transfer with U type tube similar as air conditioning chiller is designed. Then, based on the theory of heat transfer, this structure is analyzed by the theory of convection heat transfer, and the relationship between velocity, diameter and length of the convective with heat transfer coefficient are studied, so the optimized design scheme is obtained. Finally, the optimized design scheme is verified by the model experiment. Analysis of the experimental data shows that:

1) The relationship between the flow rate and the heat transfer coefficient is approximately linear. In laminar flow state, the convective heat transfer coefficient

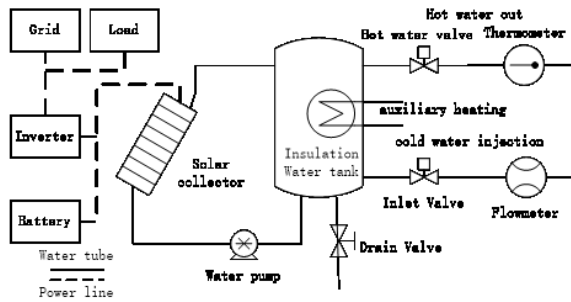

Fig. 8. Geometry of considered trapezoidal plate

is relatively low, which is not enough to completely absorb the incident power of solar energy. When the speed is accelerated further, the water flow enters the mild turbulence state, which can meet the heat absorption requirement;

2) The relationship between the diameter of the pipe and the convection heat transfer coefficient is nonlinear, there is a maximum value region, which is exactly equivalent to the 25mm diameter of the standard pipe;

References

- [1] WANG. YUNYUN, PEI. GANG, JI. JIE: *Effects of temperature factors on the optical and electrical properties of PV/T system*. Journal of solar energy 13 (2010), 1755–1761.
- [2] BERGENE. T, LOVIK. O: *Model calculation on a flat plate solar heat collector with integrated solar cells*. Solar Energy 55 (1995), No. 6, 453–462.
- [3] LU. DAN, LU. JIAN: *Experimental study on the electric heating performance of PV/T system*. building energy saving 8 (2012), 48–51.
- [4] ZHU. HUI. JUAN, PEI. GANG, FU. HUIDE, ZHANG. TAO, JI. JIE: *A comparative study on the performance of heat pipe PV/T system with different pipe spacing*. Journal of solar energy 7 (2013), 1172–1176.
- [5] ZHAO. YALI: *China household electrical appliances association*. 2015 Chinese technology conference proceedings 8 (2015), 120–125.

Received November 16, 2016